



Utrecht University

Spinoza Institute

Canonical Methods in Deterministic Quantum Mechanics

Gerard 't Hooft

<http://arxiv.org/abs/1405.1548>

Erice, June 2014

Lecture I. Deterministic Quantum Mechanics

Motivations

for searching deterministic versions of Quantum Mechanics

- Understanding physics at the Planck scale
- Obtain a more concise understanding of what a quantum mechanical calculation actually is
- Find new constraints for model building
[hope for the distant future]
- Construct faster algorithms for quantum field theoretical computer simulations [hope for the distant future]
- It's beautiful mathematical physics

The Copenhagen Interpretation in Dirac notation

- Hilbert space with bras $\langle\psi|$ and kets $|\psi\rangle$, inner product $\langle\varphi|\psi\rangle$, and a *norm* $\|\psi\|^2 \equiv \langle\psi|\psi\rangle$
- Superpositions: $|\psi'\rangle = \alpha|\psi\rangle + \beta|\varphi\rangle$, with the usual rules.
- At $t = 0$ postulate an initial state $|\psi(0)\rangle$, with $\|\psi\| = 1$, and a *Schrödinger equation*,

$$\frac{d}{dt}|\psi(t)\rangle = -iH|\psi(t)\rangle$$

H is the Hamilton operator (Hamiltonian)

- Consider at $t = T$ a possible final state $\langle\varphi(T)|$ with $\|\varphi\| = 1$
- The *probability* that the system will end in that mode will be

$$P = \|\langle\varphi(T)|\psi(T)\rangle\|^2$$

Observables \mathcal{O} are *operators* such as \hat{x} and \hat{p} ,

but their form depends on the *basis chosen*:

the \vec{x} basis, states $\{|\vec{x}\rangle\}$, operators $\hat{x} = \vec{x}$, $\hat{p} = -i\frac{\partial}{\partial \vec{x}}$, or

the \vec{p} basis, states $\{|\vec{p}\rangle\}$, operators $\hat{x} = i\frac{\partial}{\partial \vec{p}}$, $\hat{p} = \vec{p}$, or

or any other set of basis states.

The *expectation value* of \mathcal{O} is $\langle \mathcal{O} \rangle = \langle \psi | \mathcal{O} | \psi \rangle$

The outcomes of calculations do not depend on the basis chosen.

Can we make good use of this, by choosing a special basis?

Evolution operator $U(T) = e^{-iHT}$.

There *is* a special choice: the ontological basis. In this basis, $U(T) = P(T)$, which is a permutator of basis elements $|e_i\rangle$.

Can an **ontological basis** exist?

a more generic finite, deterministic, time reversible model:

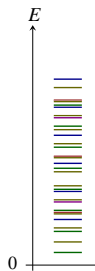
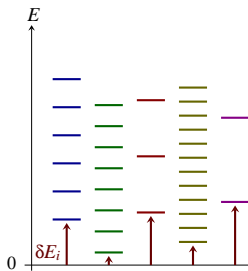
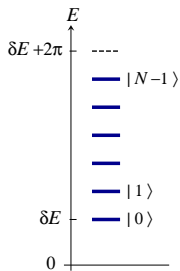
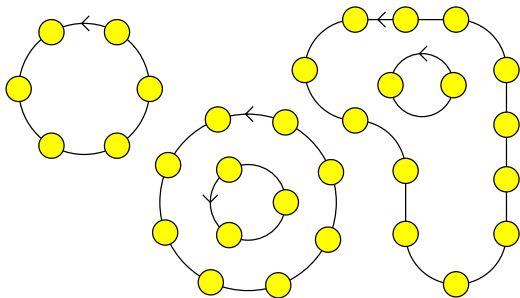

a more generic finite, deterministic, time reversible model:

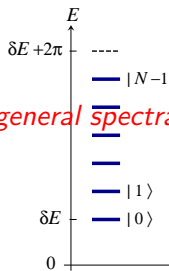
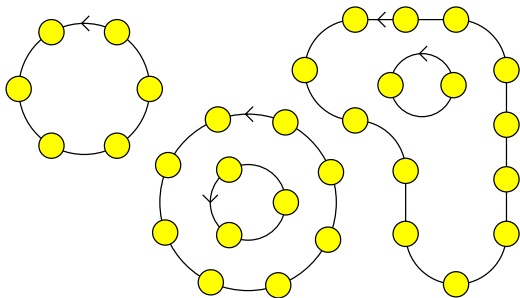

quite general spectra can emerge!

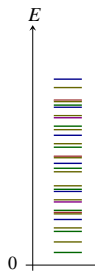
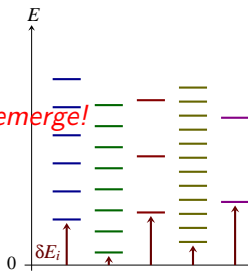

quite general spectra can emerge!

And the spectrum is the only thing invariant under a basis transformation.

The spectrum determines all dynamical features of the theory

Therefore, one may expect that, in many cases, a physical model can be approached with an ontological basis.

Examples of “quantum systems” that have an ontological basis:

- atoms with magnetic moment μ in a homogeneous magnetic field \vec{B} (Zeeman splitting); spectral lines separated at equal distances:

$$H = \mu \vec{B} \cdot \vec{L} = m_\ell \mu B, \quad m_\ell = -l, \dots, +l$$



- The harmonic oscillator (limit $l \rightarrow \infty$)
- Massless non-interacting “neutrinos” (see last year)
- Massless scalar field in 1+1 dimensions

More complex, non integrable system:

The classical, generic, cellular automaton,
appears to be equivalent to a quantum field theory, however,
it lacks rotation or Lorentz invariance.

And we could not prove this equivalence ...

difficulty: the Hamiltonian of the field theory may be
either non-local or unbounded below.

$$H = \int d^3\vec{x} \mathcal{H}(\vec{x}) , \quad \mathcal{H}(\vec{x}) > \mathcal{H}_0 .$$

The cellular automaton interpretation

Theory:

We *assume* that an ontological basis can be found for the complete Standard Model including the gravitational force.

The basis elements are “ontological states”, called $|\text{ont}\rangle_i$

Often, we won't know *which* ontological state we are in.

We can then describe the state we are in as a “*physical state*”,

$$|\varphi\rangle \equiv \sum_i \lambda_i |\text{ont}\rangle_i$$

By definition: $P_i = |\lambda_i|^2$, $\sum_i |\lambda_i|^2 = 1$

As for the *final state*, see later!

Ontological states evolve in accordance with the Schrödinger equ.

*The universe is in a **single ontological state**.*

Classical states (such as a planet moving in its orbit) can be distinguished by carefully analysing the statistics of the ontological data. Therefore:

Classical states are ontological states (**classical observables are diagonal in the ontological basis**).

Therefore, the probability that a particular classical state, $|\text{ont}(T)\rangle_c$ is seen at time $t = T$, is either 1 or 0.

Since in a physical state $|\varphi\rangle$, the probabilities are $|\lambda_i|^2$, these will also be the probabilities for obtaining the final class. states $|\text{ont}\rangle_c$.

Thus, the $|\lambda_i|^2$, the probabilities obtained from a *quantum* calculation, actually reflect *nothing else than the ordinary uncertainties* we had in specifying the initial states! **Born's rule**.

Note that *we are following the Copenhagen rules for quantum mechanics very strictly.*

The rule that $\langle \psi | \mathcal{O} | \psi \rangle = \langle \mathcal{O} \rangle$ = the expectation value for the observable \mathcal{O} , only holds if

- $|\psi\rangle$ is the wave function of the universe (an ontological state), or
- a *template* state (an Ansatz for the state of the universe), but
- *not* if $|\psi\rangle$ is a *physical* state.

Only modification: we do ask the question that should not be asked according to Copenhagen:

What is going on in reality?

We claim to know the **wave function of the universe**: it is one of the ontological states $|\text{ont}\rangle_i$.

From the one simple assumption that an *ontological basis* exists, it is easy to deduce that:

- The Bell inequalities are violated (We have genuine QM)
- The wave function always collapses *automatically*.
This is because, in the real world, we always are in a single ontological state, therefore all observed phenomena end in single classical states.
- The Born rule follows: we get the Born probability distributions if we assume – for lack of more complete information – that the initial state was a *physical state*.
Therefore we begin with probabilities $|\lambda_i|^2$, and we end with them.

We *cannot* write both the initial state *and* the final state as “physical” states, but they may be regarded as *templates* for the ontological states

The mix-up of physical states as superpositions of ontological states begins at the Planck scale, so it will be **complicated**.

We have *models*, but these are **simple**. They enjoy **locality**

We have **superdeterminism** (more about that later)

The universe will refuse ever to go into a superposition of ontological states.

There is only one world;

No many-world interpretation

there exists no ontological “pilot wave”.

No Bohm pilot

Note: This theory is primarily intended to describe the world at the Planck scale, and may be crucial for model building purposes. It is suspected that the **gravitational force** will play an important role in our understanding of quantum mechanics.

This is why the construction of explicit, realistic models is difficult; we often experience problems with locality and positivity of the **hamiltonian** (as in many other theories of Planck scale physics).

Some people think that they can “prove” that an ontological basis is impossible:

The Bell - CHSH inequality

Consider the production of an entangled state of two particles. In spin $\frac{1}{2}$ notation: Atom $\rightarrow \frac{1}{\sqrt{2}}(|\uparrow\downarrow\rangle - |\downarrow\uparrow\rangle)$ (spin $\frac{1}{2}$ notation)

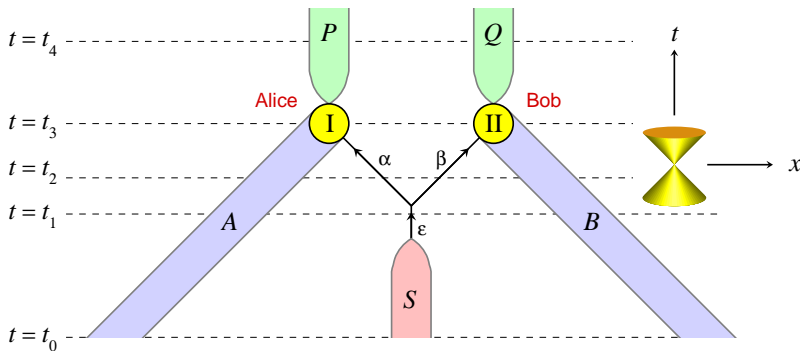

Alice measures the spin in the direction a and Bob measures the spin in the direction b . Alice finds spin $\frac{1}{2}A$, $A = \pm 1$, Bob finds spin $\frac{1}{2}B$, $B = \pm 1$. The correlation they find, according to qm, will be

$$\langle AB \rangle = -\cos(a - b)$$

But, according to Bell's theorem, this is impossible if this were a classical statistical system. Take the four cases:

$$\begin{array}{cccc} (a, b) = & (0^\circ, -45^\circ), & (90^\circ, -45^\circ), & (0^\circ, 45^\circ), & (90^\circ, 45^\circ) \\ \langle AB \rangle = & -\frac{1}{2}\sqrt{2}, & \frac{1}{2}\sqrt{2}, & -\frac{1}{2}\sqrt{2}, & -\frac{1}{2}\sqrt{2} \end{array}$$

Define $S = \langle A_1 B_1 \rangle - \langle A_2 B_1 \rangle + \langle A_1 B_2 \rangle + \langle A_2 B_2 \rangle$

qm: $S = -2\sqrt{2}$, but classical statistics: $-2 \leq S \leq 2$
 CHSH inequality

Bell's theorem proves that local counterfactual reality does not exist, not that you can't have a classical theory underlying qm

We can still have **superdeterminism**:

Theorem: there must be *correlations* between angles a , b and the atom ε .

Model: atom emits entangled electrons with opposite spin at angle c . Alice finds $A = 1$ if $|a - c| < 90^\circ$, otherwise $A = -1$

Bob finds $B = -1$ if $|b - c| < 90^\circ$, otherwise $B = +1$

Assume conditional probability $W(c|a, b) = W(c - \frac{1}{2}(a + b))$.

Which function W reproduces the qm result for $\langle AB \rangle$?

Calculation: $W(x) = \frac{1}{2}|\sin(2x)|$

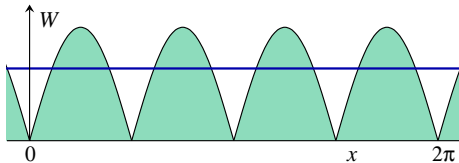

As implied by Bell's theorem: there are correlations between the *choices* of the angles a and b chosen by Alice and Bob, and the 'classical' angle c at which the atom emits its 'entangled' particles.

Only 3-point correlations; upon averaging over a , or over b , or over c , one finds the 2-point correlations to vanish.

If Bob's decision b , and the atom's emission angle c are given, Alice's decision a is not randomly distributed

→ no counterfactual realism, but "conspiracy":

- *Vacuum fluctuations* indeed give spacelike correlations without violating causality
- If indeed the ontological states contain such correlations, and *superdeterminism* demands that Alice and Bob are in an ontological state, then Alice and Bob will not be able to 'change their settings' in such a way that a non-ontological 'physical state' emerges; they have to pick an ontological state again. So the correlations persist.
- No counterfactual realism, but also no contradiction

Lecture II. Canonical Methods

The greatest challenges in finding deterministic versions of qm, or, finding a 'classical, 'ontological' theory generating all quantum features of the SM, are:

- Include the symmetries of the SM:

$$\text{Lorentz, } SU(3) \times SU(2) \times U(1) , \dots$$

note, we most often need to restrict ourselves to discrete (lattice-like) models

- Generate a Hamiltonian H that is *bounded from below*,

$$\langle H \rangle \geq E_0$$

- Reproduce locality in this Hamiltonian:

$$H = \int d^3\vec{x} \mathcal{H}(\vec{x}) , \quad \mathcal{H}(\vec{x}) \geq \mathcal{H}_0$$

Therefore, we search for canonical models, as in classical mechanics and standard qm.

PQ theory: skip

Turning a pair of ontological integers into the quantum ops \hat{q} and \hat{p} :

$$\bullet_{-2} \bullet_{-1} \bullet_0 \bullet_1 \bullet_2 \bullet_3 \bullet = \bigcirc \quad (\text{Fourier duality})$$

$$\bigcirc = \text{---} \text{---} \text{---} \quad -\pi < \eta < \pi$$

$$\left(\bullet_{-2} \bullet_{-1} \bullet_0 \bullet_1 \bullet_2 \bullet_3 \bullet \right) \otimes \text{---} \text{---} \text{---} = \text{---} \text{---} \text{---}$$

Make real number operators $-\infty < q < \infty$ as follows:

$$q = Q + \frac{1}{2\pi}\eta P$$

There is a unitary transformation of states from one basis to another: $\langle Q, \eta P | \psi \rangle = \langle q | \psi \rangle$.

Then transform

$$\langle Q, \eta P | \psi \rangle = \sum_{P=-\infty}^{\infty} \frac{1}{\sqrt{2\pi}} e^{-iP\eta P} \langle Q, P | \psi \rangle = \langle q | \psi \rangle$$

Alternatively, find the p basis: $\langle q | p \rangle = \frac{1}{\sqrt{2\pi}} e^{ipq}$

Matrix elements skip

(mathematical detail is skipped here: make the mapping $P \leftrightarrow Q$ symmetric)

In Hilbert space $\{|Q, P\rangle\}$, we have

$$\hat{q} = Q + a_Q \quad , \quad \hat{p} = 2\pi(P + a_P) \quad ,$$

$$\langle Q_1, P_1 | a_Q | Q_2, P_2 \rangle = \frac{(-1)^{P+Q+1} i P}{2\pi(P^2 + Q^2)}$$

$$\langle Q_1, P_1 | a_P | Q_2, P_2 \rangle = \frac{(-1)^{P+Q} i Q}{2\pi(P^2 + Q^2)} \quad .$$

From these:

$$[q, p] = i(1 - |\psi_{\text{edge}}\rangle\langle\psi_{\text{edge}}|) \quad , \quad \text{with} \quad \langle Q, P | \psi_{\text{edge}} \rangle = (-1)^{Q+P}$$

Transforming to a torus: skip

$$\langle \kappa | Q \rangle = \frac{1}{\sqrt{2\pi}} e^{iQ\kappa}, \quad \langle \xi | P \rangle = \frac{1}{\sqrt{2\pi}} e^{iP\xi}.$$

Find pseudoperiodic phase function $\phi(\kappa, \xi)$ obeying

$$\begin{aligned} \phi(\kappa, \xi + 2\pi) &= \phi(\kappa, \xi) + \kappa; & \phi(\kappa + 2\pi, \xi) &= \phi(\kappa, \xi); \\ \phi(\kappa, \xi) &= -\phi(-\kappa, \xi) = -\phi(\kappa, -\xi); & \phi(\kappa, \xi) + \phi(\xi, \kappa) &= \kappa\xi/2\pi. \end{aligned}$$

$$\begin{aligned} \hat{q} &= -i \frac{\partial}{\partial \kappa} + \frac{\partial}{\partial \kappa} \phi(\xi, \kappa) = -i \frac{\partial}{\partial \kappa} - \frac{\partial}{\partial \kappa} \phi(\kappa, \xi) + \frac{\xi}{2\pi} \\ \hat{p} &= -2\pi i \frac{\partial}{\partial \xi} - 2\pi \frac{\partial}{\partial \xi} \phi(\kappa, \xi) \end{aligned}$$

This gives $[\hat{q}, \hat{p}] = i$, except at $(\kappa, \xi) = (\pm\pi, \pm\pi)$ where $\phi(\kappa, \xi)$ is singular:

edge state $\langle \kappa, \xi | \psi_{\text{edge}} \rangle = \delta(\kappa - \pi) \delta(\xi - \pi)$

Extensive Hamiltonian

Let $-\pi < x < \pi$, then $x = 2 \sum_{n=1}^{\infty} \frac{(-1)^{n-1} \sin(nx)}{n}$

From that:

$$H = \pi + \sum_{n=1}^{\infty} \frac{i}{n} (U(n\delta t) - U(-n\delta t)) \rightarrow U = e^{-iH}$$

But this is not extensive: $0 \leq H < 2\pi$

An interesting extensive Hamiltonian is obtained when we use the **classical Hamilton formalism** for discrete systems.

Consider integer variables Q_i and P_i , depending on a discrete time variable T .

Let there be given a discrete energy function $H(\vec{Q}, \vec{P})$. This function must vary sufficiently slowly as Q_i and P_i vary

Can we define a unique evolution law by demanding $H(\vec{Q}, \vec{P})$ to be exactly conserved?

In the continuous case the answer is Hamilton's formalism:

$$\dot{\vec{q}} = \frac{\partial H}{\partial \vec{p}}, \quad \dot{\vec{p}} = -\frac{\partial H}{\partial \vec{q}} \quad \rightarrow \quad \dot{H}(\vec{q}, \vec{p}) = \dot{\vec{q}} \frac{\partial H}{\partial \vec{q}} + \dot{\vec{p}} \frac{\partial H}{\partial \vec{p}} = 0$$

Wrong answer: replace \dot{x} by $x(T+1) - x(T)$ and $\frac{\partial F}{\partial q}$ by $F(Q+1) - F(Q)$ or anything such

Correct procedure: *cyclically order* indices i , and update $\{Q_i, P_i\}$ for each i in that order, keeping H fixed, as follows:

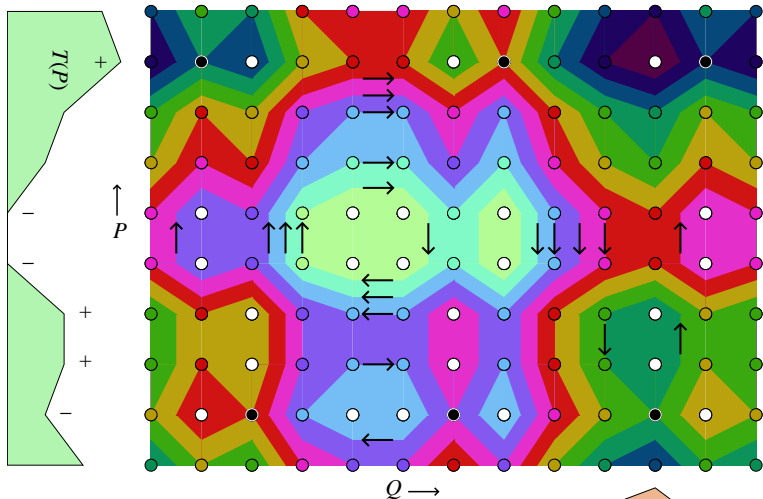

(The case
 $H = T + V$)

At each step where the index i is fixed, consider

$$(Q, P) = (Q_i, P_i).$$

First define *closed paths*, in terms of the sets $H(Q, P) = \text{fixed}$:

The path must have a sufficiently large number of points on it, and its *orientation* must be as in the continuum theory.

This can easily be made unique provided that H is sufficiently smooth.

Borderline case: H is quadratic function of integers Q and P , if the coefficient for the squares is $\frac{1}{2}$, which is the smallest possible. In that case most paths have only 4 or so points on them.

More interesting cases have slower varying functions, with lower bounds, usually non-integrable.

With given Hamiltonian, and given cyclic order of indices, this is the most direct analogue of the continuous case.

With very smooth Hamiltonians, one finds the *continuum limit* to yield the standard Hamilton equations – by checking *how fast* a system runs along its path.

In the *discrete lattice field theory*, one can also formulate such Hamiltonians.

The indices are then replaced by the discrete space coordinates \vec{x} and the field indices.

We order the coordinates by first taking all even sites, then all odd sites.

The action at the even sites all commute, same for odd sites.

In that case, this field evolution law *obeys all locality conditions.*

Now define the evolution operator U_E for a unit time step at a given classical Hamiltonian $H_{\text{class}} = E$ as

$$U_E = e^{-iH_{\text{quant}}}$$

after which

$$H_{\text{tot}} = H_{\text{quant}} + 2\pi H_{\text{class}} \geq 0$$

H_{class} is extensive, but H_{quant} is not.

How to add multiples of 2π to make also H_{quant} extensive?

The AB formalism for the cellular automaton

The discrete lattice field theory just described is example of *Cellular Automaton* of AB type.

$$U = U_A U_B$$

$U_A \equiv e^{-iA}$ on even sites, $U_B \equiv e^{-iB}$ on odd sites

$$A = \sum_{\vec{x}=\text{even}} A(\vec{x}) ; \quad B = \sum_{\vec{x}=\text{odd}} B(\vec{x})$$

$$[A(\vec{x}), A(\vec{x}')] = 0 , \quad [B(\vec{x}), B(\vec{x}')] = 0$$

$[A(\vec{x}), B(\vec{x}')] \neq 0$ only if \vec{x} and \vec{x}' are neighbors.

Baker Campbell Hausdorff:

$$e^P e^Q = e^R ,$$

$$R = P + Q + \frac{1}{2}[P, Q] + \frac{1}{12}[P, [P, Q]] + \frac{1}{12}[[P, Q], Q] + \frac{1}{24}[[P, [P, Q]], Q] +$$

+ only commutators, take $P = -iA$, $Q = -iB$, $R = -iH$.

Better: take an arbitrary member of the conjugacy class:

$$e^{\tilde{R}} = e^F e^P e^Q e^{-F} ,$$

$$\tilde{R} = R + [F, R] + \frac{1}{2}[F, [F, R]] + \frac{1}{3!}[F, [F, [F, R]]] + \dots$$

$$K = \sum_{\vec{r}} K(\vec{r}) , \quad K(\vec{r}) = A(\vec{r}) \text{ if } \vec{r} \text{ is even, and } B(\vec{r}) \text{ if } \vec{r} \text{ is odd,}$$

$$L = \sum_{\vec{r}} L(\vec{r}) , \quad L(\vec{r}) = A(\vec{r}) \text{ if } \vec{r} \text{ is even, and } -B(\vec{r}) \text{ if } \vec{r} \text{ is odd}$$

$$A(\vec{r}) = \frac{1}{2}(K(\vec{r}) + L(\vec{r})) \quad \text{and} \quad B(\vec{r}) = \frac{1}{2}(K(\vec{r}) - L(\vec{r}))$$

We can now choose F such that all odd powers of L and all even powers of K vanish. Result:

Write $[X, [Y, [Z, [U, V]]]]$ as $XYZUV$, etc., then:

$$\tilde{\mathcal{H}}(\vec{r}) = K(\vec{r}) + \frac{1}{96} \sum_{\vec{s}_1, \vec{s}_2} L(\vec{r}) K(\vec{s}_1) L(\vec{s}_2) + \frac{1}{30720} \sum_{\vec{s}_1, \dots, \vec{s}_4} L(\vec{r}), \left(8K(\vec{s}_1) K(\vec{s}_2) - L(\vec{s}_1) L(\vec{s}_2) \right) K(\vec{s}_3) L(\vec{s}_4) + \dots$$

Commutators only non-vanishing between neighbors. Therefore, $\tilde{\mathcal{H}}(\vec{r})$ can serve as *Hamiltonian density*.

K and L are operators. Questions:

- Can we make $\tilde{\mathcal{H}}(\vec{r})$ resemble the SM Hamilton density?
- Is the series sufficiently convergent??

As for the next term, shorthand:

$$\begin{aligned}\tilde{\mathcal{H}} = & K + \frac{1}{96} LKL + \frac{1}{30720} L(8K^2 - L^2)KL + \\ & \frac{1}{7741440} L(51K^4 + 76LKLK - 33L^2K^2 - 44KL^2K + \frac{3}{8}L^4) KL \\ & + \dots\end{aligned}$$